

# INOX 200

POWERFUL LIFTER FOR USE IN PHARMA AND FOOD INDUSTRY

## TOUGH, HYGIENIC AND WATER RESISTANT

INOX 200 is made of electropolished stainless steel and handles loads up to 200 kg. It is designed for demanding environments as in pharma and food industries, where production equipment is subject to strict hygiene and cleaning requirements (IP66).

The INOX 200 can be equipped with manual or electrical tools for handling of e.g. reels, boxes or drums depending on the requirements. The lifter features remote control, built-in overload protection, safety clutch and battery indicator.

All tools for the INOX 200 are made of stainless steel and available in various sizes. The three mast heights can be combined with six different leg types.

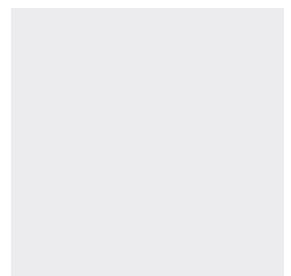
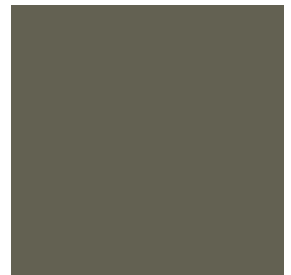
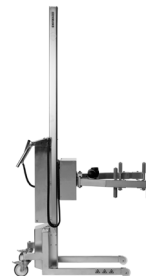

# INOX 200

## LEG TYPES

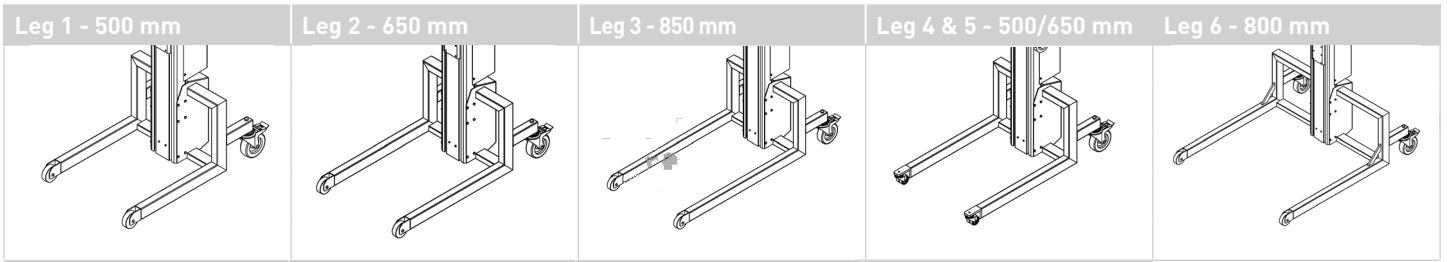

## TOOLS

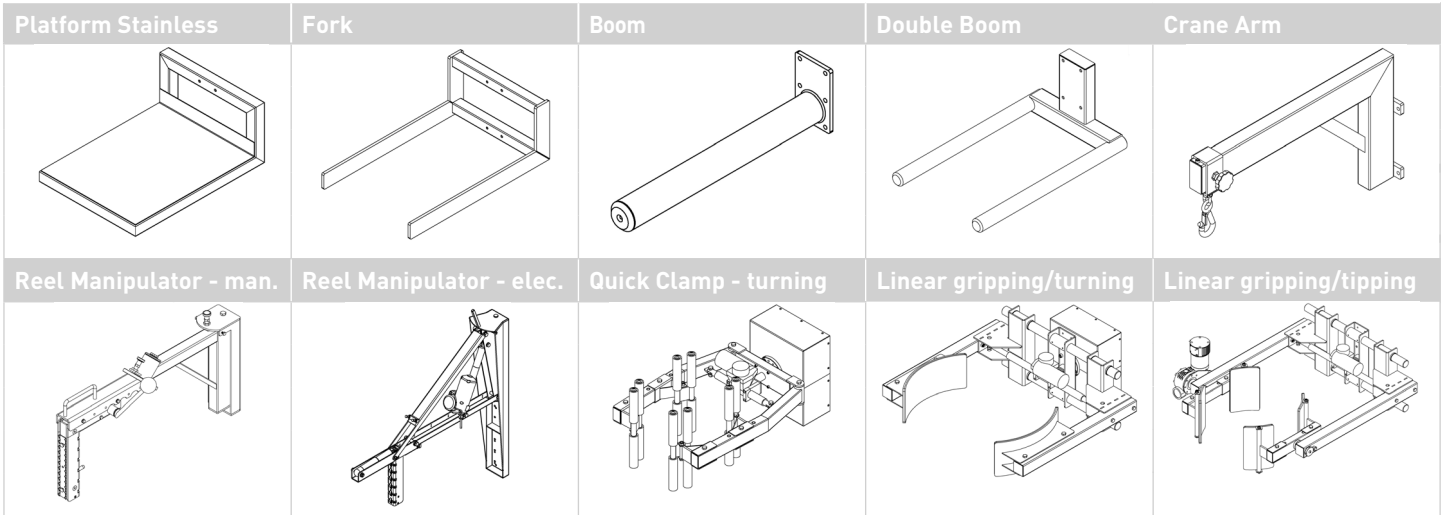

Type	Capacity	Lifting height	Mast height	Speed	Batteries	Weight
	kg	mm	mm	mm/sec	Voltage / AH	kg
200 L	200	1228	1610	125	24/18	67
200 M	200	1598	1980	125	24/18	71
200 H	200	2028	2410	125	24/18	76

## WHEELS

Leg 1, Leg 2, Leg 3 and Leg 6:  
 Front wheels, fixed Ø80 mm  
 Rear wheels, swivel Ø125 mm with brakes

Leg 4 and Leg 5 (max payload 130 kg):  
 Front wheels, double swivel Ø75 mm  
 Rear wheels, swivel Ø125 mm with brakes

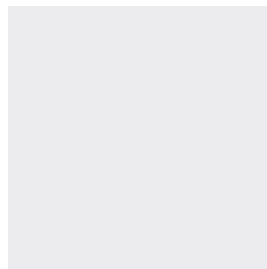

**SEE VIDEOS:**  
[WWW.YOUTUBE.COM/HOVMANDIMPACT](http://WWW.YOUTUBE.COM/HOVMANDIMPACT)

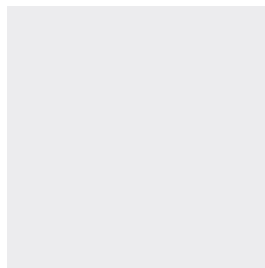

ASP bvba  
 Baanakkerweg 3  
 B-3060 Bertem

+32 (0)16 36 12 24  
 info@asp-online.be  
 www.asp-online.be